

VIEW - XX

PVC 'C' Type drift Eliminator PVC BRACKET

ITEM No. 2

(All dimensions are in mm)

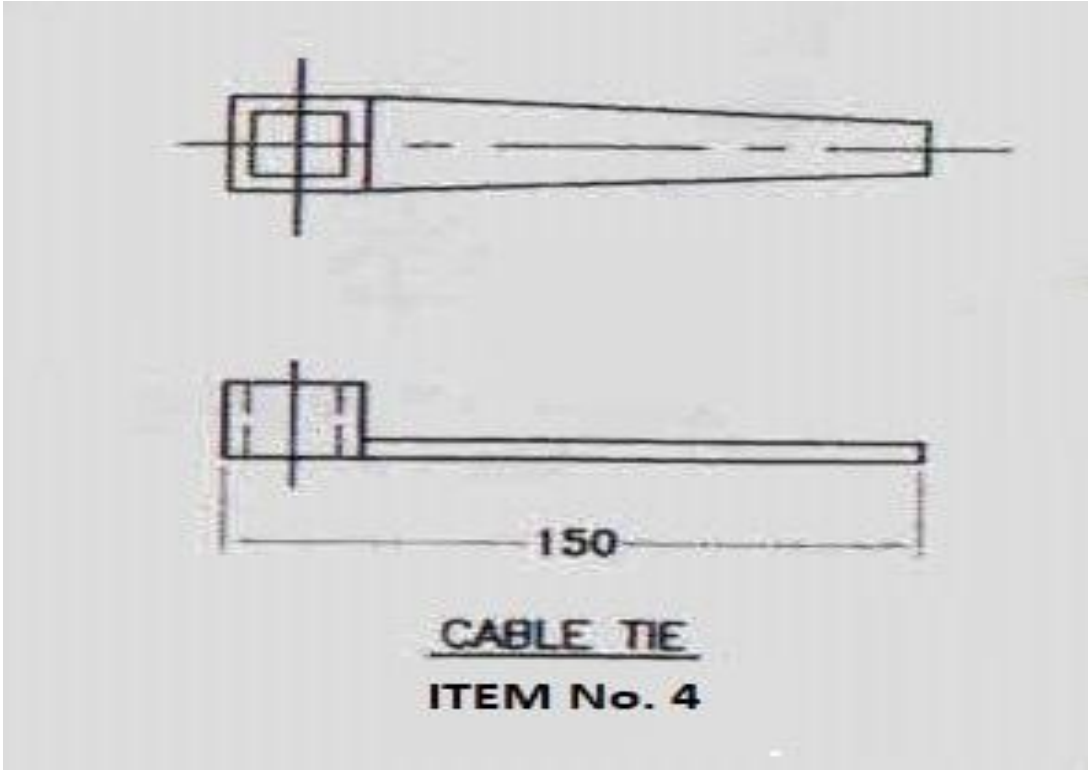
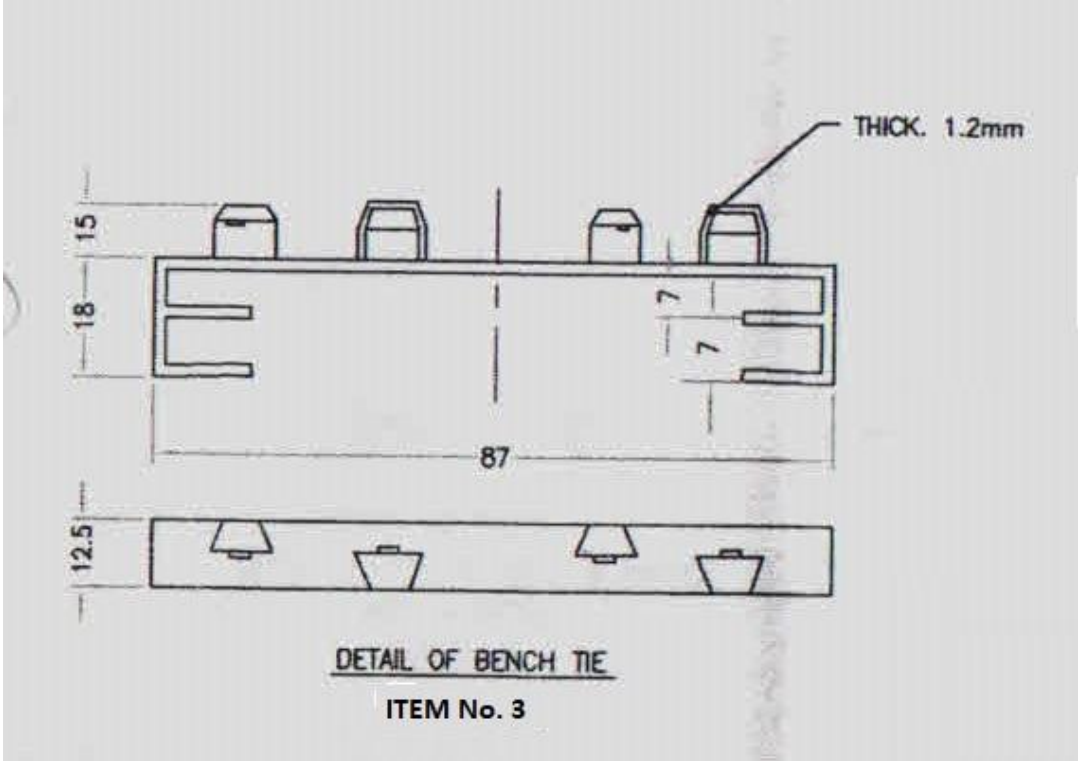

(All dimensions are in mm)

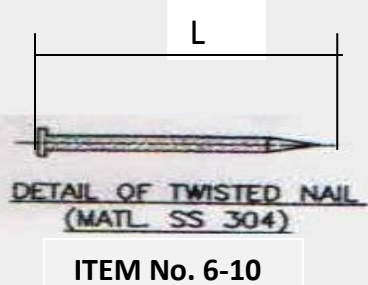
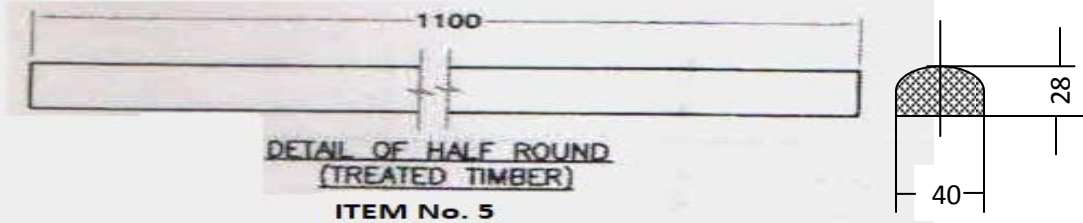

L = 1 1/2" , 2" , 2 1/2" 3" , 3 1/2"

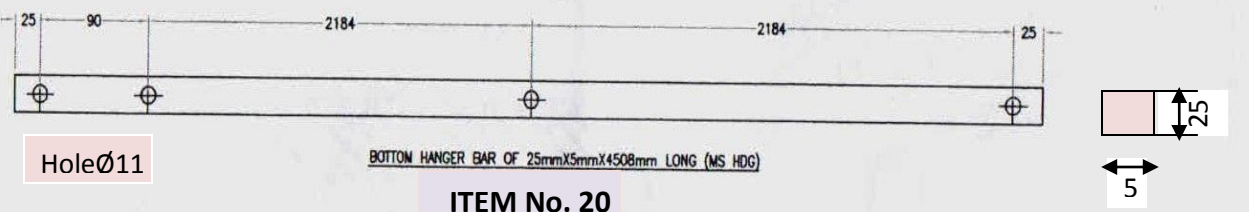
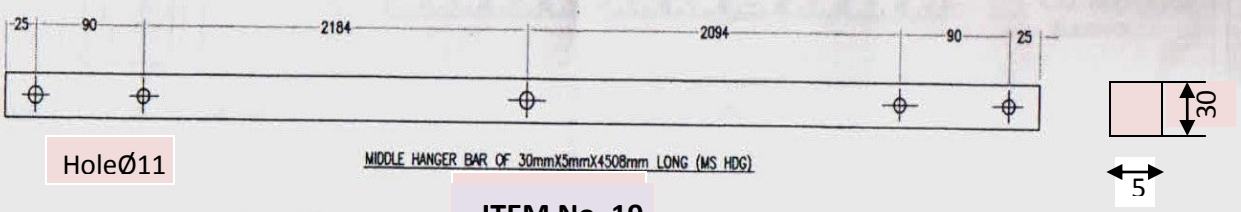
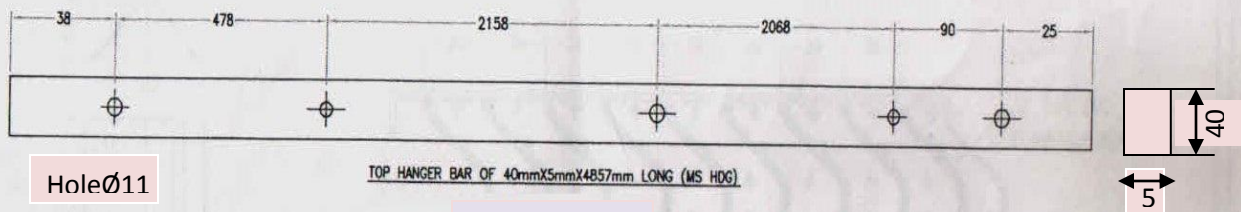

(All dimensions are in mm)

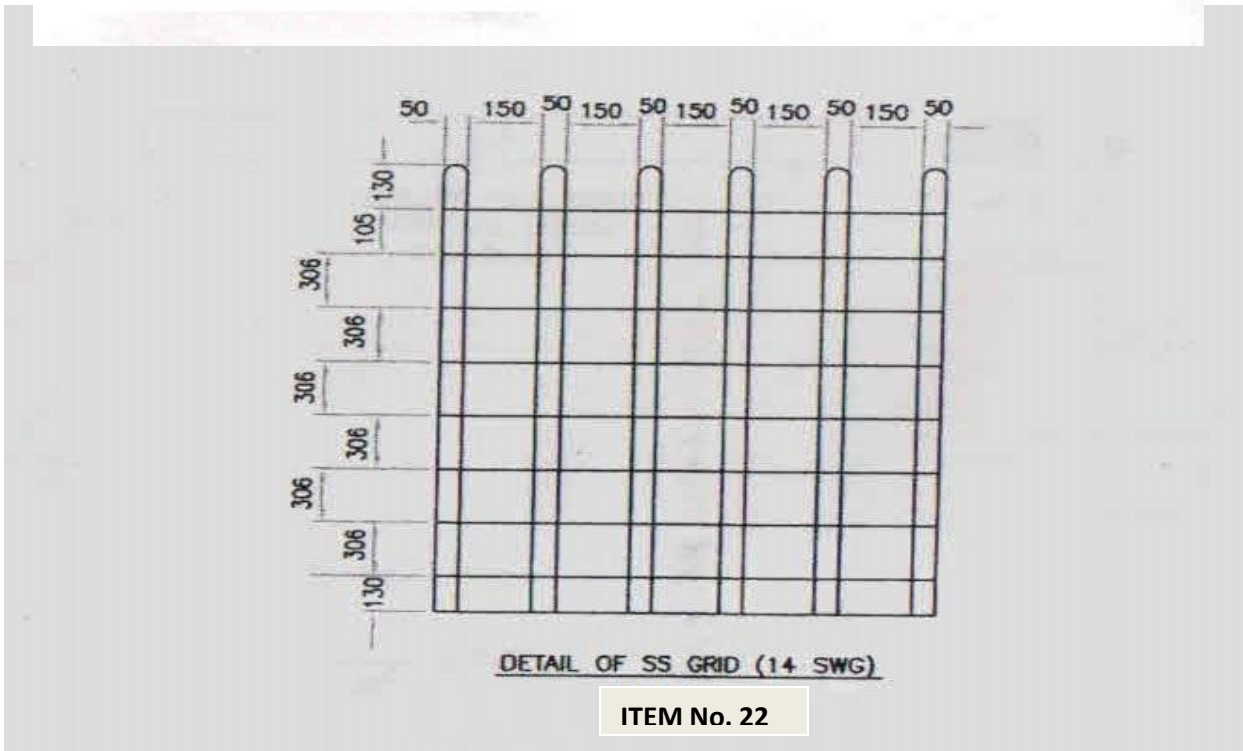
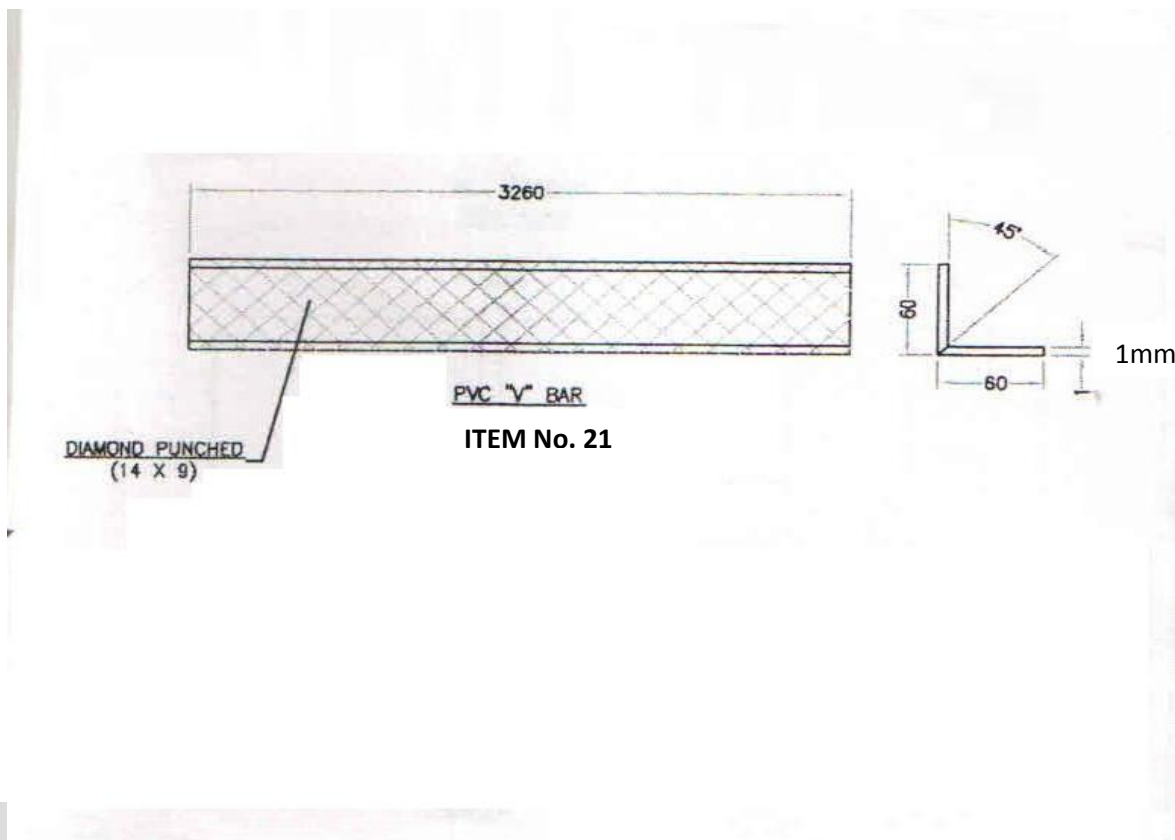

(All dimensions are in mm)